

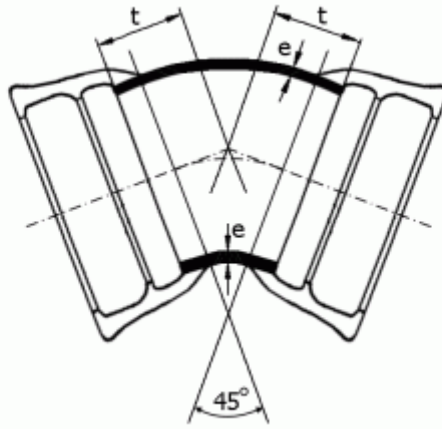

●Type T Double Socket 45° Bend



K=12

Unit: mm

DN	e	t	Weight (kg)
80	7.0	55	7.7
100	7.2	65	10.1
150	7.8	85	17.4
200	8.4	110	27.0
250	9.0	130	38.5
300	9.6	150	53.0
350	10.2	175	70.0
400	10.8	195	89.0
450	11.4	220	92.6
500	12.0	240	139.0
600	13.2	285	202.0
700	14.4	330	282.0
800	15.6	370	378.0
900	16.8	415	496.0
1000	18.0	460	635.0
1100	19.2	505	805.9
1200	20.4	550	986.0